

# Glassforce 1700 Pool Gate Fittings



## Product Features

- A matching range of pool fittings to combine function and design for latches and pool gate fittings.
- All products have been tested in accordance with NZ Building Code.
- Spring hinges have a weight capacity up to 40kg and are tested to 20,000 cycles.
- Allegro Hydraulic Floor Mounted Closer has a weight capacity up to 80kg, simple installation with no floor cut-out required and easy adjustment of closing and latching speeds.
- All products are manufactured from 316 stainless for long life and serviceability.
- Latches have built in stops and come complete with magnetic catches. Fixing plates for either round or square posts are included and a Slip On glass-to-glass (no glass cut-out needed) option is available.
- Note, pool gates must always be hinged to be opened outwards, away from the pool.



# Glassforce 1700 Pool Gate Fittings

## Adjustable Spring Hinge, Wall/Post to Glass RH

Product Code	Description	Finish
PL13PS	Adj hinge, Wall/Post to Glass RH	PSS
PL13SS	Adj hinge, Wall/Post to Glass RH	SSS

### Note

- Handing is from outside pool area, door must open outwards.
- Adapter plate for Round or Square Wall/Post Fixing included
- 316 Stainless

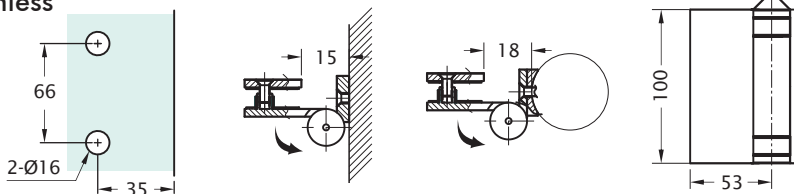

## Adjustable Spring Hinge, Wall/Post to Glass LH

Product Code	Description	Finish
PL12PS	Adj hinge, Wall/Post to Glass LH	PSS
PL12SS	Adj hinge, Wall/Post to Glass LH	SSS

### Note

- Handing is from outside pool area, door must open outwards.
- Adapter plate for Round or Square Wall/Post Fixing included
- 316 Stainless

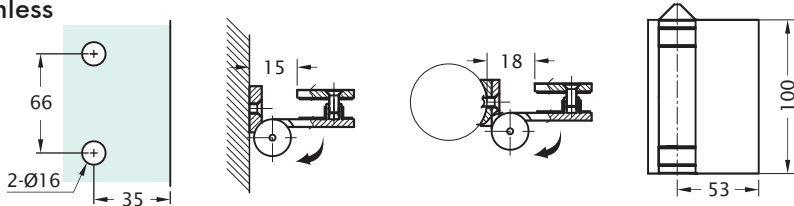

## Adjustable Spring Hinge, Glass to Glass

Product Code	Description	Finish
PL10PS	Adjustable Pool Hinge Glass to Glass	PSS
PL10SS	Adjustable Pool Hinge Glass to Glass	SSS

### Note

- 316 Stainless
- Door must open outwards

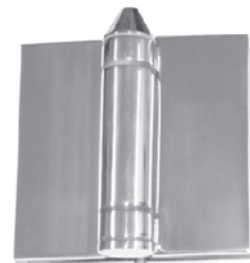
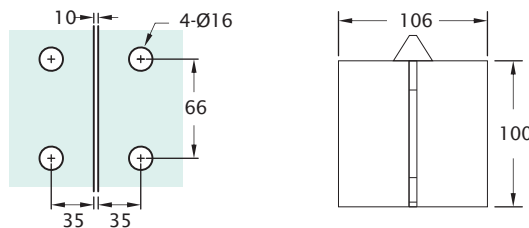

## Pool Gate, Glass Door Stop

Product Code	Description	Finish
PL11PS	Pool Gate Stop	PS
PL11SS	Pool Gate Stop	SS

### Note

- 316 Stainless

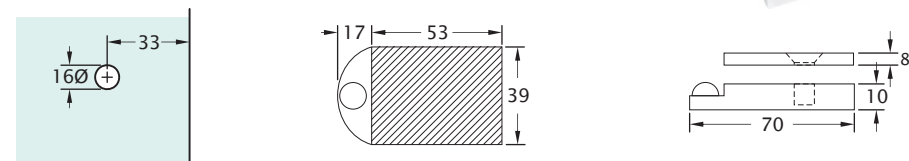

# Glassforce 1700 Pool Gate Fittings

## Pool Latch, 180° Glass to Glass

Product Code	Description	Finish
PL1-180PS	Pool Gate Latch, 180°	PS
PL1-180SS	Pool Gate Latch, 180°	SS

### Note

- 316 Stainless
- Magnetic safety door latch included

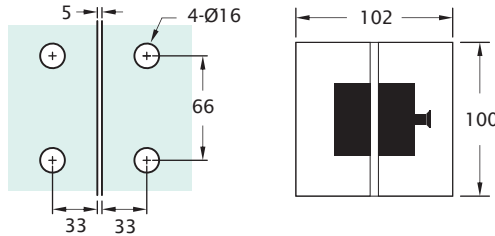

## Pool Latch, 180° Glass to Glass slip on (no holes required)

Product Code	Description	Finish
PL14PS	Pool Gate Latch, 90° slip-on	PS
PL14SS	Pool Gate Latch, 90° slip-on	SS

### Note

- 316 Stainless
- Magnetic safety door latch included
- No glass cut-out required

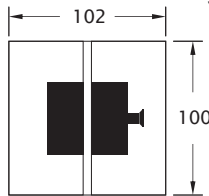

## Pool Latch, Glass to Round or Square Post

Product Code	Description	Finish
PL3PS	Pool Gate Latch, Square or Round Post	PSS
PL3SS	Pool Gate Latch, Square or Round Post	SSS

### Note

- 316 Stainless
- Magnetic safety door latch included
- Adaptor Plate for Round Post Fixing included

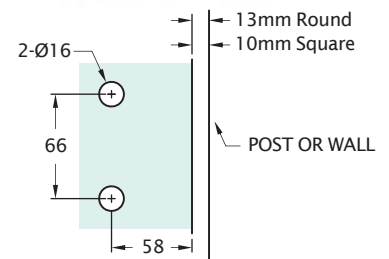
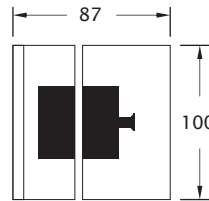
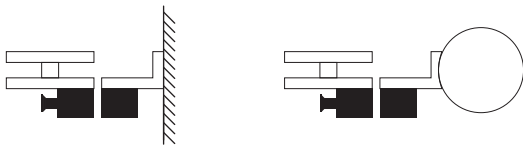

## Pool Latch, 90° Glass to Glass

Product Code	Description	Finish
PL2-90PS	Pool Gate Latch, 90°	PSS
PL2-90SS	Pool Gate Latch, 90°	SSS

### Note

- 316 Stainless
- Magnetic safety door latch included

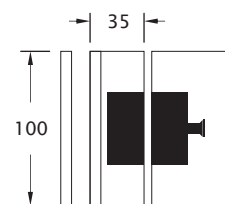
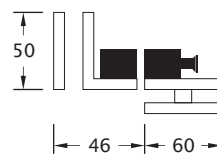
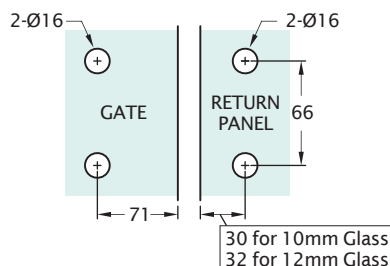

# Glassforce 1700 Pool Gate Fittings

## Allegro Hydraulic Surface Mounted Closer

Product Code	Description	Finish
NV402SS	Surface Mounted Closer NHO	SS
NV403PS	Cover Plates	PS

### Note

- Can be used with standard Patch Fittings
- For 10/12mm Glass

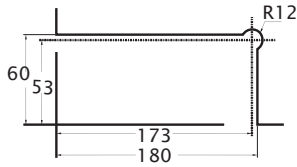

## Floor Spring, Medium Duty

Product Code	Description	Finish
FS4NHOSS	Heavy Door, Non Hold Open 130kg	SS
FS8SS	Floor Spring Spindle, 15mm	SS
FS9SS	Floor Spring Spindle, 20mm	SS
NVRESIN	Floor Spring Sealing Compound	

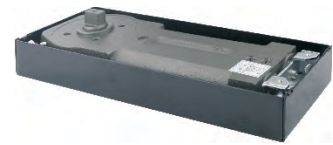

### Note

- Adjustable Closing & Latching Speeds
- Includes Cover Plate

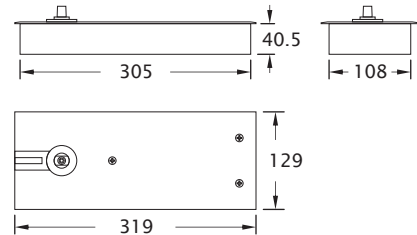

# Glassforce 1700 Pool Gate Fittings

## Pivot Arm, Patch to Patch

Product Code	Description	Finish
PL7PS	Pivot Arm, Patch to Patch	PSS
PL7SS	Pivot Arm, Patch to Patch	SSS

### Note

- 316 Stainless
- When using floor Springs outside we recommend using Resin to seal the floor spring.

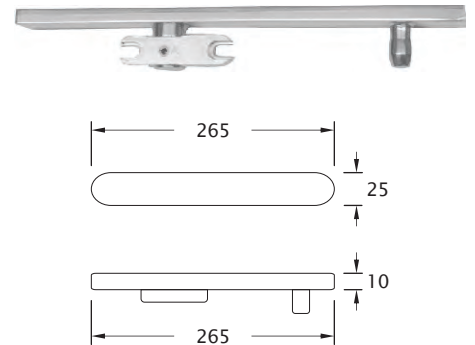

## Pivot Arm, Glass to Patch

Product Code	Description	Finish
PL6SS	Pivot Arm, Glass to Patch	PSS
PL6SS	Pivot Arm, Glass to Patch	SSS

### Note

- 316 Stainless

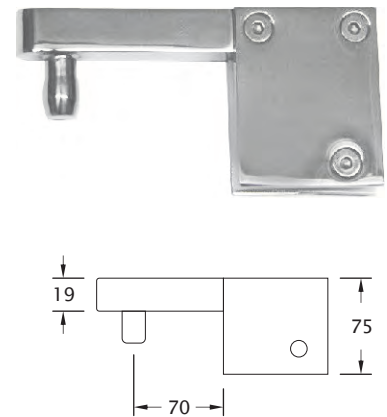
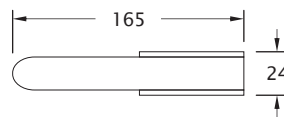
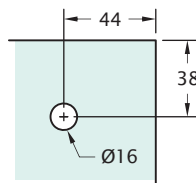

## Pivot Arm, Wall to Patch

Product Code	Description	Finish
PL5PS	Pivot Arm, Wall/Post to Patch	PSS
PL5SS	Pivot Arm, Wall/Post to Patch	SSS

### Note

- 316 Stainless

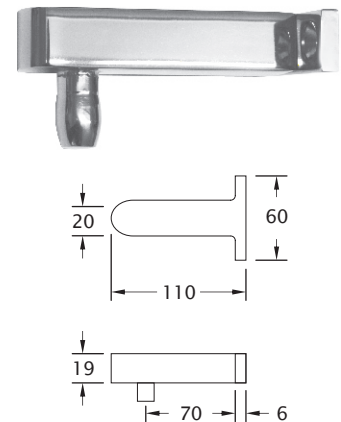
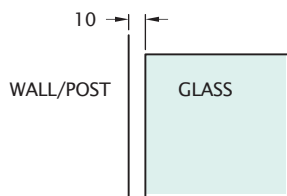

## Pivot Arm, Wall to Patch

Product Code	Description	Finish
PL8PSS	Pivot Arm, Wall/Post to Patch	PSS
PL8SS	Pivot Arm, Wall/Post to Patch	SSS

### Note

- 316 Stainless

