

# Shower Handles

## Double D

Product Code	Description
NV210PS	Double D, 210mm ctc
NV210SS	Double D, 210mm ctc
NV250PS	Double D, 250mm ctc
NV250SS	Double D, 250mm ctc
NV250BC	Double D, 250mm ctc

### Finish

PS  
SS  
PS  
SS  
BC

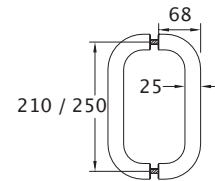
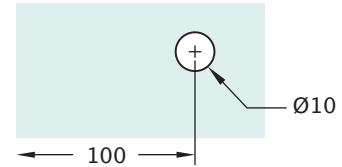

## Single D

Product Code	Description	Finish
NV270PS	Single D Handle and Pull 250mm ctc	PS
NV270SS	Single D Handle and Pull 250mm ctc	SS
NV290PS	Single D Handle/Towel Rail & Pull 400mm ctc	PS
NV290SS	Single D Handle/Towel Rail & Pull 400mm ctc	SS

### Finish

PS  
SS  
PS  
SS

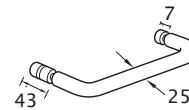

## Palermo

Product Code	Description
NVP210PS	Double Handle, 210mm ctc
NVP210SS	Double Handle, 210mm ctc
NVP250PS	Double Handle, 250mm ctc
NVP250SS	Double Handle, 250mm ctc
NVP250BC	Double Handle, 250mm ctc

### Finish

PS  
SS  
PS  
SS  
BC

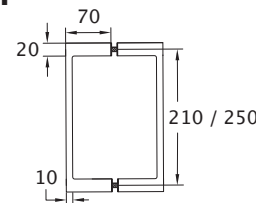

## Cuboid

Product Code	Description
NV43PS	Double Handle, 250mm ctc 38 × 25mm
NV43SS	Double Handle, 250mm ctc 38 × 25mm

### Finish

PS  
SS

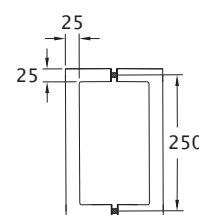

## Designer - Square & Round Pulls

Product Code	Description
NV38PS	19mm Box Section Designer Pull 210 ctc
NV38SS	19mm Box Section Designer Pull 210 ctc
NV39PS	19mm Box Section Designer Pull 250 ctc
NV39SS	19mm Box Section Designer Pull 250 ctc
NV41PS	19mm Round Section Designer Pull 210 ctc
NV41SS	19mm Round Section Designer Pull 210 ctc
NV42PS	19mm Round Section Designer Pull 250 ctc
NV42SS	19mm Round Section Designer Pull 250 ctc

### Finish

PS  
SS  
PS  
SS  
PS  
SS  
PS  
SS

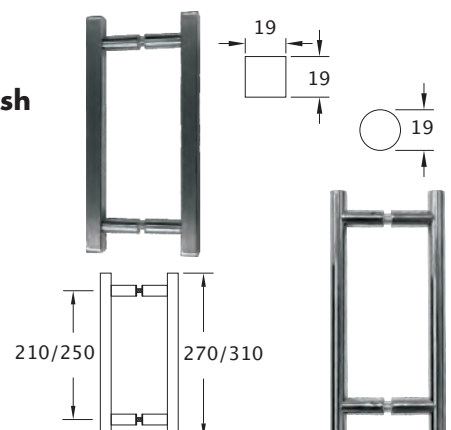

## Pull Knob

Product Code	Description	Finish
NVSK38CP	Square Double Pull, 38mm×38mm×43mm	CP
NVSK38SC	Square Double Pull, 38mm×38mm×43mm	SC

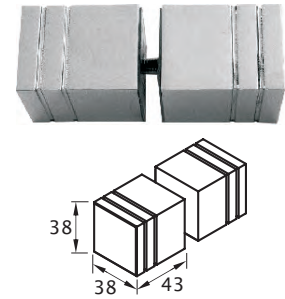
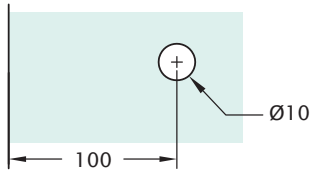

## Pull Knob

Product Code	Description	Finish
NVSK40CP	Round Double Pull, 25mm dia×43mm	CP
NVSK40SC	Round Double Pull, 25mm dia×43mm	SC

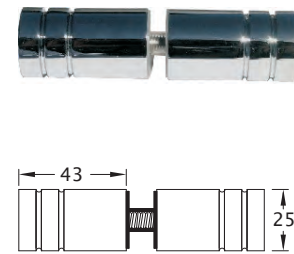
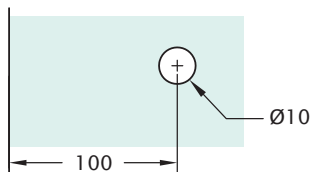

## Pull Knob

Product Code	Description	Finish
NVSK45CP	Round Double Pull, 25mm dia×30mm	CP

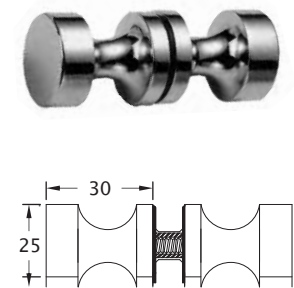
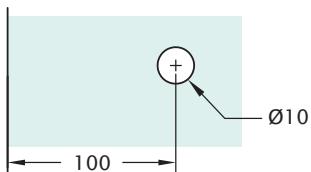

## Pull Knob

Product Code	Description	Finish
NVSK60CP	Round Double Pull, 38mm dia×43mm	CP

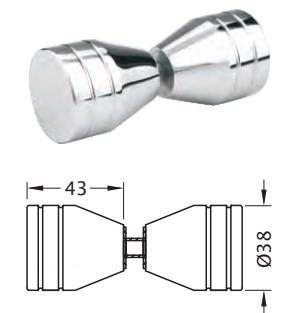
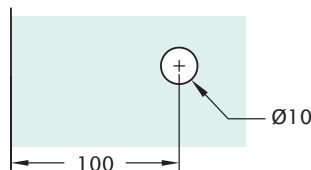

## Square Pull

Product Code	Description	Finish
NVSK55SQCP	Square Double Pull, 70×50×24mm	CP
NVSK55SQSC	Square Double Pull, 70×50×24mm	SC

